



**ELECTROSURGICAL**  
INSTRUMENTS CATALOG

**MEDICA S.R.L.**

Instruments

HIGH FREQUENCY INNOVATION

Per Informazioni e preventivi:  
Fax. 075 916711  
Email. [sales@medica-srl.eu](mailto:sales@medica-srl.eu)



# OPHTHALMIC BIPOLAR FORCEPS



McPHERSON  
(STR.)  
110-100



McPHERSON  
(CRV.)  
110-110



COAPTATION  
NADLER  
110-120



110-130



IRIS (STR.)  
110-180



IRIS (CRV.)  
110-190



JEWELER #5  
110-140



JEWELER #4  
110-150



TENZEL  
110-160



JEWELER #7  
110-170

Cat #	Description	Tip (mm)	Size
110-100	McPHERSON (STR.)	0.5	3 <sup>1</sup> / <sub>2</sub> " (9.0 cm)
110-110	McPHERSON (CRV.)	0.5	3 <sup>1</sup> / <sub>2</sub> " (9.0 cm)
110-120	COAPTATION NADLER	0.5	4" (10.2 cm)
110-130	COAPTATION	0.5	4 <sup>1</sup> / <sub>4</sub> " (10.8 cm)
110-140	JEWELER #5	MICRO, 0.5	4 <sup>1</sup> / <sub>2</sub> " (11.5 cm)
110-150	JEWELER #4	MICRO, 0.5	4 <sup>1</sup> / <sub>2</sub> " (11.5 cm)
110-160	TENZEL	MICRO, 0.5	4" (10.2 cm)
110-170	JEWELER #7	MICRO, 0.5	4 <sup>1</sup> / <sub>2</sub> " (11.5 cm)
110-180	IRIS (STR.)	1.0	4 <sup>1</sup> / <sub>4</sub> " (10.8 cm)
110-190	IRIS (CRV.)	1.0	4 <sup>1</sup> / <sub>4</sub> " (10.8 cm)

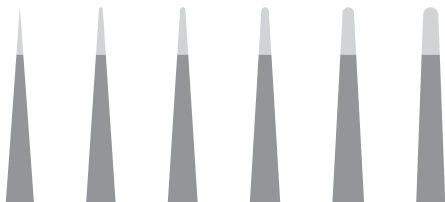

NEEDLE 0.5mm 0.7mm 1.0mm 1.5mm 2.0mm  
Available Tip Widths Always Specify Tips Width

For your convenience, add the following tip extension to product code.  
Needle Tip (-00), 0.5 mm (-05), 1.0 mm (-10) and 2.0 mm (-20)

HIGH FREQUENCY INNOVATION



# PLASTIC & RECONSTRUCTIVE

## BIPOLAR FORCEPS

ADSON  
110-200



SEMKIN  
110-220



CUSHING  
110-230



CUSHING  
110-235



CUSHING (GURSH)  
110-240



GERALD (STR.)  
110-300



GERALD (CRV.)  
110-310



GERALD BAYONET  
110-320



For your convenience, add the following tip extension to product code.  
Needle Tip (-00), 0.5 mm (-05), 1.0 mm (-10) and 2.0 mm (-20)

Cat #	Description	Tip (mm)	Size
110-200	ADSON	1.0	4 <sup>3</sup> / <sub>4</sub> " (12.1 cm)
110-206	ADSON	1.0	6" (15.2cm)
110-220	SEMKIN	.5	5 <sup>1</sup> / <sub>2</sub> " (14.0 cm)
110-230	CUSHING	1.0, 1.5	6 <sup>1</sup> / <sub>4</sub> " (15.9 cm)
110-235	CUSHING	1.0, 2.0	7" (17.8 cm)
110-240	CUSHING (GURSH)	2.0	7" (17.8 cm)
110-300	GERALD (STR.)	1.0, 1.5	7" (17.8 cm)
110-310	GERALD (CRV.)	1.0, 1.5	7" (17.8 cm)
110-320	GERALD BAYONET	1.0, 1.5	7 <sup>1</sup> / <sub>4</sub> " (18.4 cm)



# NEUROSURGICAL BIPOLAR FORCEPS

**JANSEN BAYONET**  
110-350



**JANSEN BAYONET**  
110-360



**MALIS**  
110-400



**SCOVILLE  
GREENWOOD**  
110-430



**YASARGIL**  
110-440



**HARDY BAYONET**  
110-460



**HARDY BAYONET  
(ANGLED)**  
110-470



For your convenience, add the following tip extension to product code.

Needle Tip (-00), 0.5 mm (-05), 1.0 mm (-10) and 2.0 mm (-20)

Cat #	Description	Tip (mm)	Size
110-340	JANSEN BAYONET	0.5, 1.0, 1.5	5 <sup>1</sup> / <sub>4</sub> " (15.9 cm)
110-350	JANSEN BAYONET	0.5, 1.0, 1.5	6" (15.2 cm)
110-360	JANSEN BAYONET	0.5, 1.0, 1.5	7" (17.8 cm)
110-370	JANSEN BAYONET	1.0, 1.5, 2.0	8" (20.4 cm)
110-400	MALIS	0.5, 1.0, 2.0	7" (17.8 cm)
110-430	SCOVILLE-GREENWOOD	1.0, 1.5	7 <sup>1</sup> / <sub>2</sub> " (19.1 cm)
110-440	YASARGIL	1.0, 1.5	7 <sup>3</sup> / <sub>4</sub> " (19.7 cm)
110-460	HARDY BAYONET	1.0	8 <sup>1</sup> / <sub>2</sub> " (21.6 cm)
110-470	HARDY BAYONET (ANGLED)	1.0	8 <sup>1</sup> / <sub>2</sub> " (21.6 cm)



# MONOPOLAR FORCEPS

Cat #	Description	Tip (mm)	Size
110-500	JEWELER # 4	MICRO	4 1/2" (11.5 cm)
110-510	JEWELER # 7	MICRO	4 1/2" (11.5 cm)
110-520	ADSON	1.0	4 3/4" (12.1 cm)
110-530	POTTS-SMITH	2.0	7" (17.8 cm)
110-540	POTTS-SMITH	2.0	8 1/4" (21.0 cm)
110-550	POTTS-SMITH	2.0	9 1/2" (24.1 cm)
110-555	MALIS	1.0, 1.5	7" (17.8 cm)
110-560	JANSEN BAYONET	1.5	5 1/4" (13.3 cm)
110-570	JANSEN BAYONET	1.5	6 1/4" (15.9 cm)
110-580	JANSEN BAYONET	2.0	7 1/2" (19.1 cm)
110-590	JANSEN BAYONET	2.0	8 1/4" (21.0 cm)
110-582	JANSEN BAYONET (UPWARD CURVED TIP)	2.0	7 1/2" (19.1 cm)
110-592	JANSEN BAYONET (UPWARD CURVED TIP)	2.0	8 1/4" (21.0 cm)

JEWELER # 4  
110-500



JEWELER # 7  
110-510



ADSON  
110-520



POTTS-SMITH  
110-530



POTTS-SMITH  
110-540



MALIS  
110-555



JANSEN BAYONET  
110-580



JANSEN BAYONET  
(ANGLED UP)  
110-582



For your convenience, add the following tip extension to product code.

Needle Tip (-00), 0.5 mm (-05), 1.0 mm (-10) and 2.0 mm (-20)



# NON-STICK BIPOLAR FORCEPS

McPHERSON (STR.)  
110-100 NS



McPHERSON (CRV.)  
110-110 NS



JEWELER #5  
110-140 NS



JEWELER #4  
110-150 NS



ADSON  
110-200 NS



SEMKIN  
110-220 NS



CUSHING  
110-230 NS



CUSHING  
110-235 NS



More designs are available in Non-Stick Bipolar Forceps.

Use "NS" extension to any regular Bipolar Forceps for conversion into Non-Stick Bipolar Forceps.

Available tip size

0.7mm, 1.0mm, 1.5mm and 2.0mm.



# NON-STICK BIPOLAR FORCEPS



**GERALD BAYONET**  
110-320 NS



**JANSEN BAYONET**  
110-360 NS



**SCOVILLE-GREENWOOD**  
110-430 NS



**YASARGIL**  
110-440 NS



**HARDY BAYONET**  
110-460 NS

More designs are available in Non-Stick Bipolar Forceps.  
Use "NS" extension to any regular Bipolar Forceps for conversion into Non-Stick Bipolar Forceps.  
Available tip size  
0.7mm, 1.0mm, 1.5mm and 2.0mm.



# BIPOLAR HAND-SWITCH FORCEPS

**JEWELER #4**  
110-150 HS



**SEMKIN**  
110-220 HS



**JANSEN BAYONET**  
110-370 HS

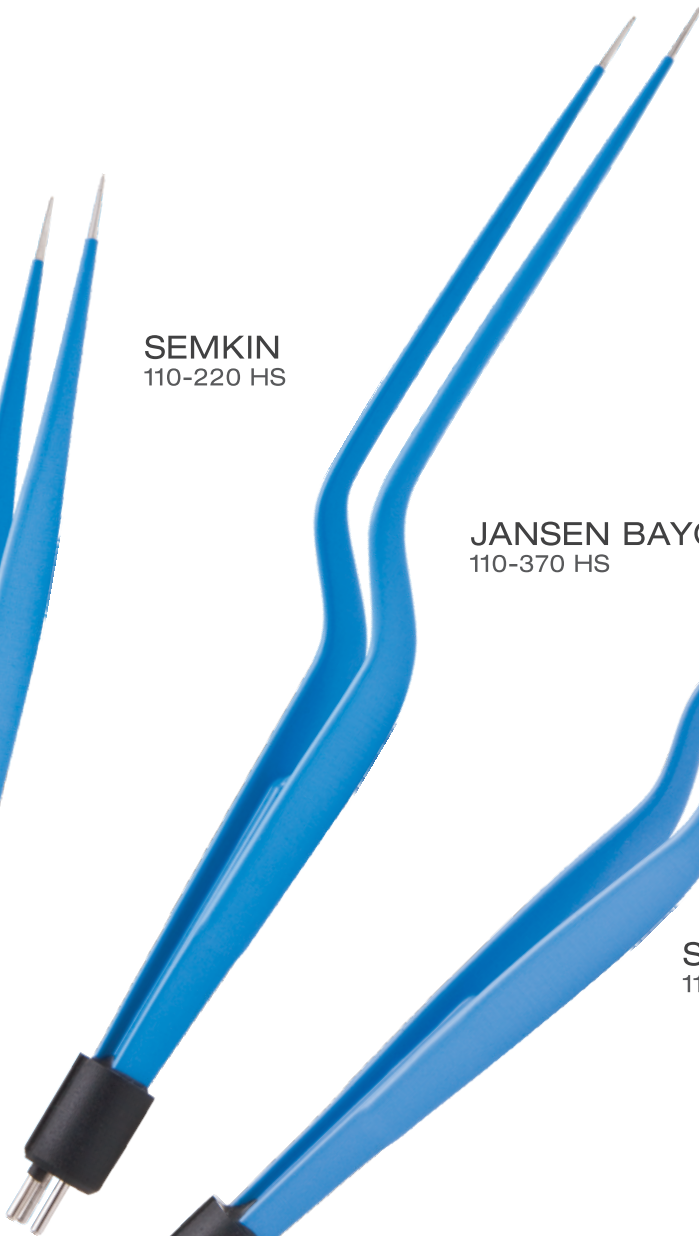

**SCOVILLE-GREENWOOD**  
110-430 HS

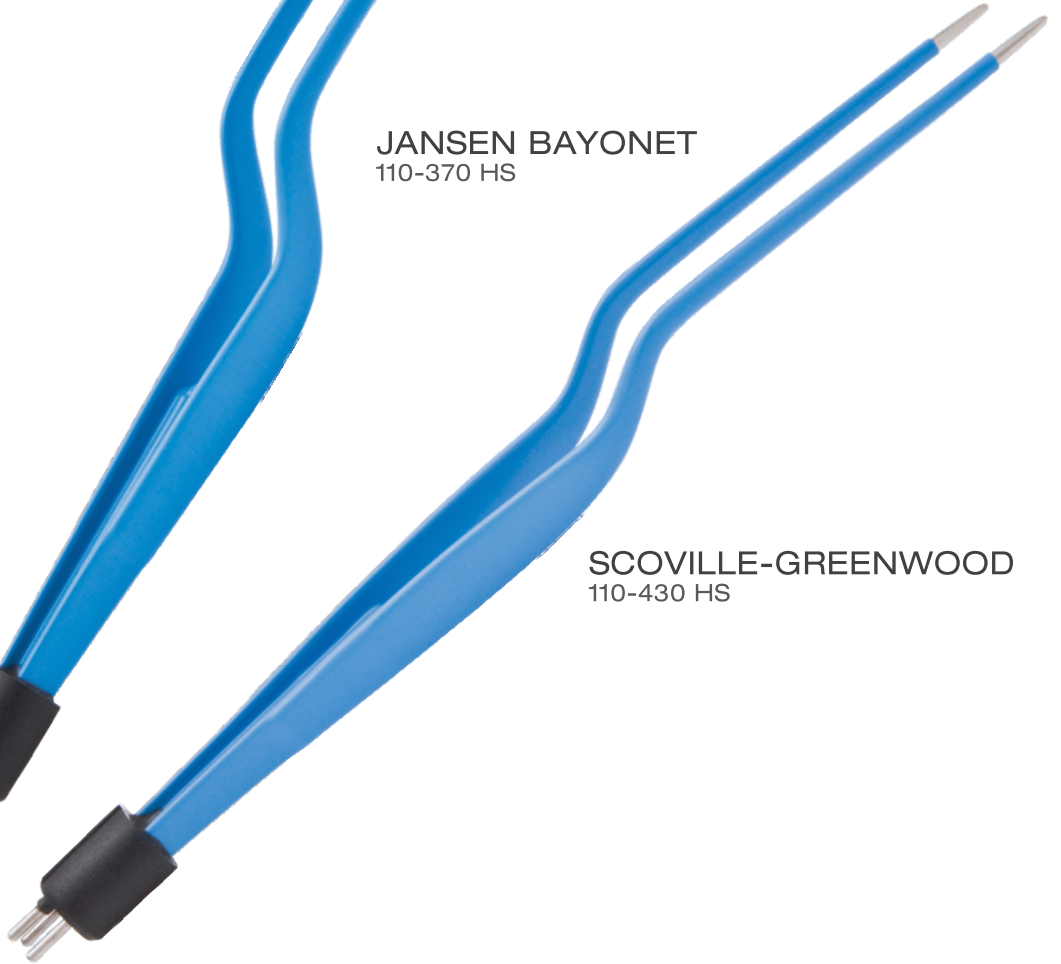

3 PIN CONNECTOR

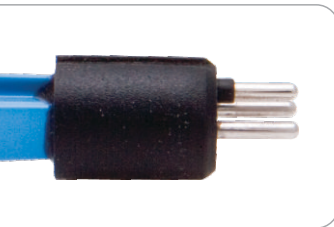

More Bipolar Hand-switch forceps are available.  
Use "HS" extension to any regular bipolar forceps.

Cat #	Description	Tip (mm)	Size
110-150HS	JEWELER #4	0.5	4 <sup>1</sup> / <sub>2</sub> " (11.5 cm)
110-220HS	SEMKIN	0.75	5 <sup>1</sup> / <sub>2</sub> " (14.0 cm)
110-370HS	JANSEN BAYONET	0.75	7 <sup>1</sup> / <sub>2</sub> " (19.1 cm)
110-430HS	SCOVILLE-GREENWOOD	1.5	7 <sup>3</sup> / <sub>4</sub> " (19.7 cm)





# IRRIGATION BIPOLAR FORCEPS



**HARDY BAYONET**  
110-460 IR



**JANSEN BAYONET**  
110-370 IR



**SCOVILLE-GREENWOOD**  
110-430 IR



**GERALD BAYONET**  
110-320 IR



**CUSHING**  
110-230 IR

More Bipolar Irrigation forceps are available.  
Use "IR" extension to any regular bipolar forceps.

Cat #	Description	Tip (mm)	Size
110-460 IR	HARDY BAYONET	1.5	8 <sup>1</sup> / <sub>2</sub> " (21.6 cm)
110-370 IR	JANSEN BAYONET	1.5	8" (20.4 cm)
110-430 IR	SCOVILLE-GREENWOOD	1.5	7 <sup>3</sup> / <sub>4</sub> " (19.7 cm)
110-320 IR	GERALD BAYONET	1.0	7 <sup>1</sup> / <sub>4</sub> " (18.4 cm)
110-230 IR	CUSHING	1.0	6 <sup>1</sup> / <sub>4</sub> " (15.9 cm)



# MONOPOLAR HAND-SWITCH FORCEPS

JANSEN BAYONET  
110-560 HS



HAND ACTUATED  
SWITCH

JANSEN BAYONET  
110-580 HS

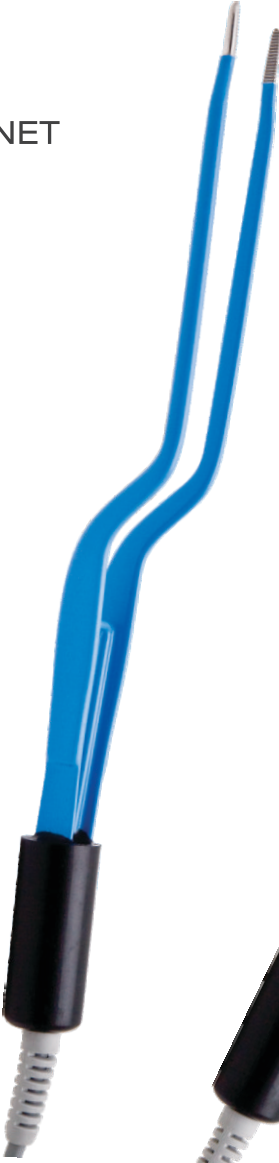

POTTS-SMITH  
110-540 HS



POTTS-SMITH  
110-550 HS



Cat #	Description	Tip (mm)	Size
110-560 HS	JANSEN BAYONET	2.0	5 <sup>1</sup> / <sub>2</sub> " (14.0 cm)
110-580 HS	JANSEN BAYONET	2.0	7 <sup>1</sup> / <sub>2</sub> " (19.0 cm)
110-590 HS	JANSEN BAYONET	2.0	8 <sup>1</sup> / <sub>4</sub> " (21.0 cm)
110-530 HS	POTTS-SMITH	2.0	7" (18.0 cm)
110-540 HS	POTTS-SMITH	2.0	8 <sup>1</sup> / <sub>4</sub> " (21.0 cm)
110-550 HS	POTTS-SMITH	2.0	9 <sup>1</sup> / <sub>2</sub> " (24.0 cm)



# EUROPEAN BIPOLAR FORCEPS



McPHERSON  
310-100



McPHERSON (ANGLED)  
310-102



JEWELER #5  
310-110



JEWELER #5 (ANGLED)  
310-112



JEWELER #7  
310-115



ADSON  
310-300

Cat #	Description	Tip (mm)	Size
310-100	McPHERSON	0.5	4" (10.2 cm)
310-102	McPHERSON (ANGLED)	0.5	4" (10.2 cm)
310-110	JEWELER # 5	0.5, 0.7	4 1/2" (11.5 cm)
310-112	JEWELER # 5 (ANGLED)	0.5, 0.7	4 1/2" (11.5 cm)
310-115	JEWELER # 7	0.5, 0.7	4 1/2" (11.5 cm)
310-300	ADSON	1.0	4 3/4" (12.1 cm)
310-310	ADSON	1.0	6" (15.0 cm)

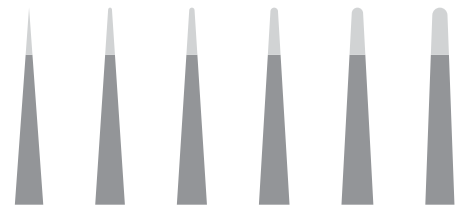

NEEDLE 0.5mm 0.7mm 1.0mm 1.5mm 2.0mm  
Available Tip Widths Always Specify Tips Width

For your convenience, add the following tip extension to product code.

Needle Tip (-00), 0.5 mm (-05), 1.0 mm (-10) and 2.0 mm (-20)



# EUROPEAN BIPOLAR FORCEPS

Cat #	Description	Tip (mm)	Size
310-120	STRAIGHT	0.5, 1.0, 2.0	6" (15.0 cm)
310-130	STRAIGHT	0.5, 1.0, 2.0	7" (18.0 cm)
310-140	STRAIGHT	0.5, 1.0, 2.0	7 <sup>3</sup> / <sub>4</sub> " (20.0 cm)
310-150	STRAIGHT	0.5, 1.0, 2.0	8 <sup>3</sup> / <sub>4</sub> " (22.0 cm)
310-260	STRAIGHT	0.5, 1.0, 2.0	9 <sup>1</sup> / <sub>2</sub> " (24.0 cm)

**STRAIGHT**  
310-120



**STRAIGHT**  
310-130



**STRAIGHT**  
310-140



**STRAIGHT**  
310-150



**STRAIGHT (ANGLED)**  
310-122



**STRAIGHT (ANGLED)**  
310-132



**STRAIGHT (ANGLED)**  
310-142



**STRAIGHT (ANGLED)**  
310-152



For your convenience, add the following tip extension to product code.  
Needle Tip (-00), 0.5 mm (-05), 1.0 mm (-10) and 2.0 mm (-20)

Cat #	Description	Tip (mm)	Size
310-122	STRAIGHT (ANGLED)	0.5, 1.0, 2.0	6" (15.0 cm)
310-132	STRAIGHT (ANGLED)	0.5, 1.0, 2.0	7" (18.0 cm)
310-142	STRAIGHT (ANGLED)	0.5, 1.0, 2.0	7 <sup>3</sup> / <sub>4</sub> " (20.0 cm)
310-152	STRAIGHT (ANGLED)	0.5, 1.0, 2.0	8 <sup>3</sup> / <sub>4</sub> " (22.0 cm)
310-262	STRAIGHT (ANGLED)	0.5, 1.0, 2.0	9 <sup>1</sup> / <sub>2</sub> " (24.0 cm)



# EUROPEAN BIPOLAR FORCEPS

Cat #	Description	Tip (mm)	Size
310-160	BAYONET	0.5, 1.0, 2.0	6 <sup>1</sup> / <sub>2</sub> " (16.5 cm)
310-170	BAYONET	0.5, 1.0, 2.0	7" (18.0 cm)
310-180	BAYONET	0.5, 1.0, 2.0	7 <sup>3</sup> / <sub>4</sub> " (20.0 cm)
310-190	BAYONET	0.5, 1.0, 2.0	8 <sup>3</sup> / <sub>4</sub> " (22.0 cm)
310-200	BAYONET	0.5, 1.0, 2.0	9 <sup>1</sup> / <sub>2</sub> " (24.0 cm)
310-162	BAYONET (ANGLED UP)	0.5, 1.0, 2.0	6 <sup>1</sup> / <sub>2</sub> " (16.5 cm)
310-172	BAYONET (ANGLED UP)	0.5, 1.0, 2.0	7" (18.0 cm)
310-182	BAYONET (ANGLED UP)	0.5, 1.0, 2.0	7 <sup>3</sup> / <sub>4</sub> " (20.0 cm)

**BAYONET**  
310-160



**BAYONET**  
310-170



**BAYONET**  
310-180



**BAYONET (ANGLED UP)**  
310-162



**BAYONET (ANGLED UP)**  
310-172



**BAYONET (ANGLED UP)**  
310-182



**BAYONET (ANGLED DOWN)**  
310-165



**BAYONET (ANGLED DOWN)**  
310-175



**BAYONET (ANGLED DOWN)**  
310-185



For your convenience, add the following tip extension to product code.

Needle Tip (-00), 0.5 mm (-05), 1.0 mm (-10) and 2.0 mm (-20)

Cat #	Description	Tip (mm)	Size
310-192	BAYONET (ANGLED UP)	0.5, 1.0, 2.0	8 <sup>3</sup> / <sub>4</sub> " (22.0 cm)
310-202	BAYONET (ANGLED UP)	0.5, 1.0, 2.0	9 <sup>1</sup> / <sub>2</sub> " (24.0 cm)
310-165	BAYONET (ANGLED DOWN)	0.5, 1.0, 2.0	6 <sup>1</sup> / <sub>2</sub> " (16.5 cm)
310-175	BAYONET (ANGLED DOWN)	0.5, 1.0, 2.0	7" (18.0 cm)
310-185	BAYONET (ANGLED DOWN)	0.5, 1.0, 2.0	7 <sup>3</sup> / <sub>4</sub> " (20.0 cm)
310-195	BAYONET (ANGLED DOWN)	0.5, 1.0, 2.0	8 <sup>3</sup> / <sub>4</sub> " (22.0 cm)
310-205	BAYONET (ANGLED DOWN)	0.5, 1.0, 2.0	9 <sup>1</sup> / <sub>2</sub> " (24.0 cm)

 **EUROPEAN NON-STICK**  
BIPOLAR FORCEPS



**McPHERSON**  
310-100 NS



**McPHERSON (ANGLED)**  
310-102 NS



**JEWELER #5**  
310-110 NS



**JEWELER #5 (ANGLED)**  
310-112 NS



**ADSON**  
310-300 NS

More designs are available in Non-Stick Bipolar Forceps.  
Use "NS" extension to any regular Bipolar Forceps for conversion into Non-Stick Bipolar Forceps.  
Available tip size  
0.7mm, 1.0mm, 1.5mm and 2.0mm.



# EUROPEAN NON-STICK BIPOLAR FORCEPS

**STRAIGHT**  
310-120 NS



**STRAIGHT**  
310-130 NS



**STRAIGHT**  
310-140 NS



**STRAIGHT**  
310-150 NS



**BAYONET**  
310-160 NS



**BAYONET**  
310-170 NS



**BAYONET**  
310-180 NS



**BAYONET**  
310-190 NS



More designs are available in Non-Stick Bipolar Forceps.

Use "NS" extension to any regular Bipolar Forceps for conversion into Non-Stick Bipolar Forceps.

Available tip size

0.7mm, 1.0mm, 1.5mm and 2.0mm.



# EUROPEAN IRRIGATION

## BIPOLAR FORCEPS

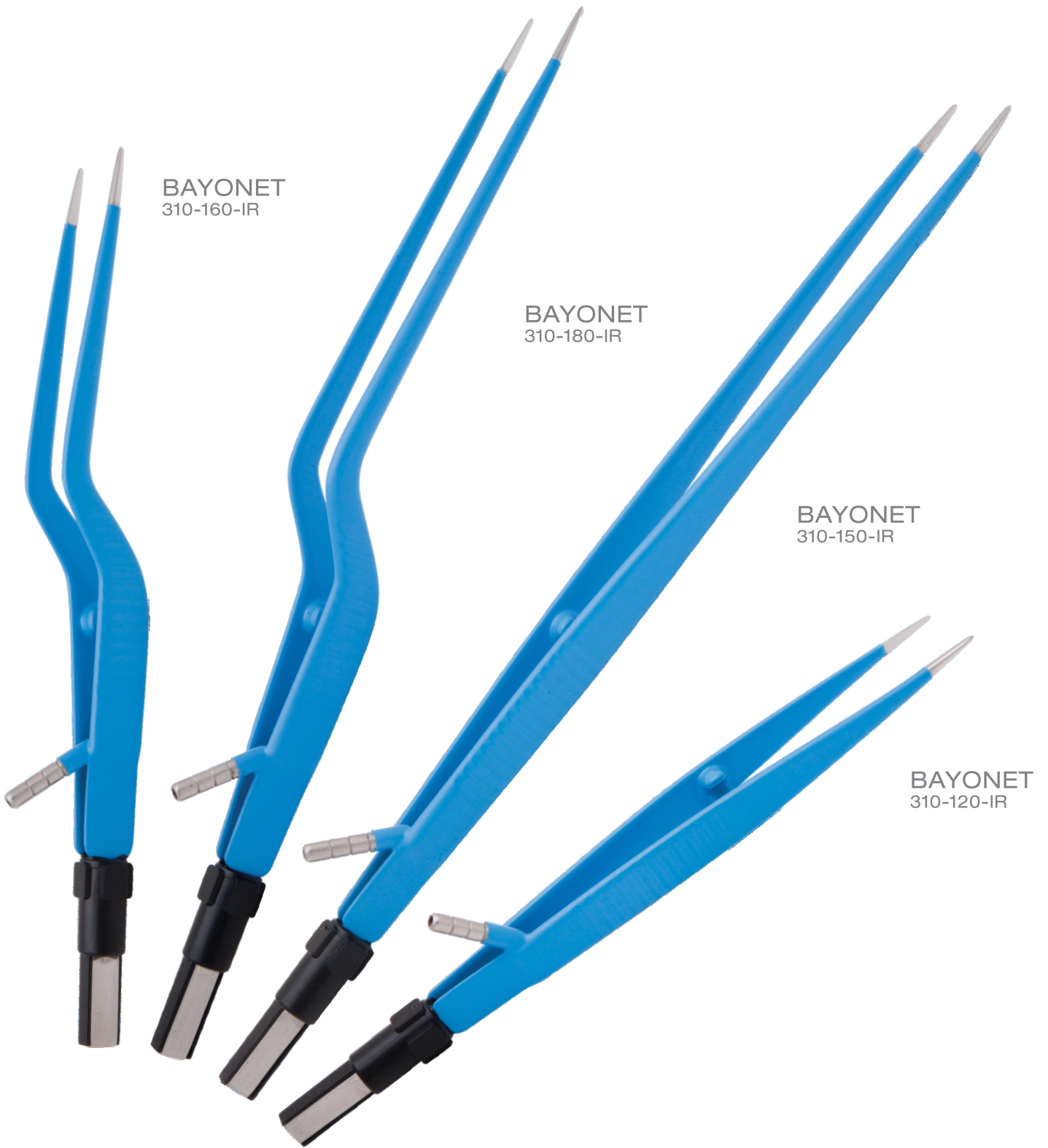

BAYONET  
310-160-IR

BAYONET  
310-180-IR

BAYONET  
310-150-IR

BAYONET  
310-120-IR

Any European Bipolar Forceps can be converted into "Irrigation Bipolar Forceps" as shown in previous pages. Add extension "IR" at the end.





# EUROPEAN BIPOLAR FORCEPS

Cat #	Description	Tip (mm)	Size
610-120	STRAIGHT	0.5, 1.0, 2.0	6" (15.0 cm)
610-130	STRAIGHT	0.5, 1.0, 2.0	7" (18.0 cm)
610-140	STRAIGHT	0.5, 1.0, 2.0	7 <sup>3</sup> / <sub>4</sub> " (20.0 cm)
610-150	STRAIGHT	0.5, 1.0, 2.0	8 <sup>3</sup> / <sub>4</sub> " (22.0 cm)
610-260	STRAIGHT	0.5, 1.0, 2.0	9 <sup>1</sup> / <sub>2</sub> " (24.0 cm)

**STRAIGHT**  
610-120



**STRAIGHT**  
610-130



**STRAIGHT**  
610-140



**STRAIGHT**  
610-150



**STRAIGHT (ANGLED)**  
610-122



**STRAIGHT (ANGLED)**  
610-132



**STRAIGHT (ANGLED)**  
310-142



**STRAIGHT (ANGLED)**  
610-152



Cat #	Description	Tip (mm)	Size
610-122	STRAIGHT (ANGLED)	0.5, 1.0, 2.0	6" (15.0 cm)
610-132	STRAIGHT (ANGLED)	0.5, 1.0, 2.0	7" (18.0 cm)
610-142	STRAIGHT (ANGLED)	0.5, 1.0, 2.0	7 <sup>3</sup> / <sub>4</sub> " (20.0 cm)
610-152	STRAIGHT (ANGLED)	0.5, 1.0, 2.0	8 <sup>3</sup> / <sub>4</sub> " (22.0 cm)
610-262	STRAIGHT (ANGLED)	0.5, 1.0, 2.0	9 <sup>1</sup> / <sub>2</sub> " (24.0 cm)



# EUROPEAN BIPOLAR FORCEPS

Cat #	Description	Tip (mm)	Size
610-160	BAYONET	0.5, 1.0, 2.0	5 <sup>1</sup> / <sub>2</sub> " (14.0 cm)
610-170	BAYONET	0.5, 1.0, 2.0	7" (18.0 cm)
610-180	BAYONET	0.5, 1.0, 2.0	7 <sup>3</sup> / <sub>4</sub> " (20.0 cm)
610-190	BAYONET	0.5, 1.0, 2.0	8 <sup>3</sup> / <sub>4</sub> " (22.0 cm)
610-200	BAYONET	0.5, 1.0, 2.0	9 <sup>1</sup> / <sub>2</sub> " (24.0 cm)

BAYONET  
610-160



BAYONET  
610-170



BAYONET  
610-180



BAYONET  
610-190



BAYONET (ANGLED UP)  
610-182



BAYONET (ANGLED UP)  
610-192



BAYONET (ANGLED DOWN)  
310-185



BAYONET (ANGLED DOWN)  
610-195



SILICONE EUROPEAN BIPOLAR CABLE  
190-310



Cat #	Description	Tip (mm)	Size
610-182	STRAIGHT (ANGLED UP)	0.5, 1.0, 2.0	7 <sup>3</sup> / <sub>4</sub> " (20.0 cm)
610-192	STRAIGHT (ANGLED UP)	0.5, 1.0, 2.0	8 <sup>3</sup> / <sub>4</sub> " (22.0 cm)
610-185	STRAIGHT (ANGLED DOWN)	0.5, 1.0, 2.0	7 <sup>3</sup> / <sub>4</sub> " (20.0 cm)
610-195	STRAIGHT (ANGLED DOWN)	0.5, 1.0, 2.0	8 <sup>3</sup> / <sub>4</sub> " (22.0 cm)



# DISPOSABLE MOLDED BIPOLAR FORCEPS



**JEWELER #5**  
215-140



**JEWELER #5 ANGLED**  
215-145



**CUSHING**  
215-245



**JANSEN BAYONET**  
215-370



**DISPOSABLE BIPOLAR CABLE**  
190-100 D



Cat #	Description	Tip (mm)	Size
215-140	JEWELER # 5	0.5	4" (10.2 cm)
215-145	JEWELER # 5 (ANGLED)	0.5	4" (10.2 cm)
215-245	CUSHING	1.0	8" (20.4 cm)
215-370	JANSEN BAYONET	1.0	8" (20.4 cm)



# DISPOSABLE BIPOLAR FORCEPS



**GERALD (Str)**  
210-300



**JANSEN BAYONET  
(IRRIGATION)**  
210-360 IR



**JANSEN BAYONET**  
210-370



**JEWELER #5**  
210-140



**ADSON**  
210-200



**DISPOSABLE BIPOLAR CABLE**  
190-100 D



Forceps are supplied with 3m cable.  
Available in Sterile/Non-Sterile packaging.  
Sterilization by Ethylene Oxide (EO).

More designs are available in Disposable Bipolar  
Forceps.  
Use 210-Series with any regular Bipolar Forceps  
for conversion into Disposable Bipolar Forceps.



# DISPOSABLE BIPOLAR FORCEPS

DISPOSABLE BIPOLAR CABLE



**JEWELER #5**  
410-110



**STRAIGHT FORCEPS**  
410-140



**BAYONET FORCEPS**  
410-180



**STRAIGHT FORCEPS**  
(Disposable without cable)  
510-140



**STRAIGHT ANG**  
(Disposable without cable)  
510-142

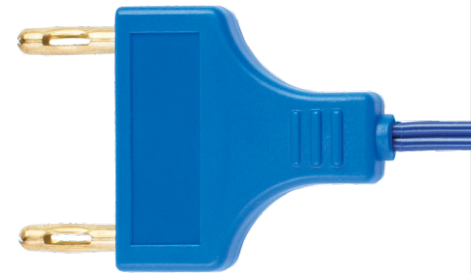

Forceps are supplied with 3m cable.  
Available in Sterile/Non-Sterile packaging.  
Sterilization by Ethylene Oxide (EO).

More designs are available in Disposable Bipolar Forceps.  
Use 410-Series with any regular Bipolar Forceps for conversion into Disposable Bipolar Forceps.

**HIGH FREQUENCY INNOVATION**



# DIATHERMY INSTRUMENTS



TUNER WARWICK (STR.)  
320-200



TUNER WARWICK (CRV.)  
320-202



SURGICAL SCISSORS (STR.)  
320-220



SURGICAL SCISSORS (CRV.)  
320-222

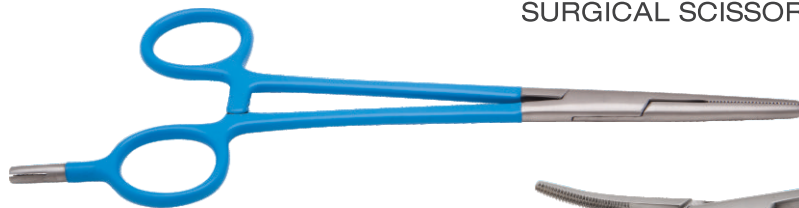

WILSON HEY FORCEPS (STR.)  
320-240



WILSON HEY FORCEPS (CRV.)  
320-242



ARTERY FORCEPS (STR.)  
320-260



ARTERY FORCEPS (CRV.)  
320-262



ABBEEY NEEDLE (17.5 cm)  
320-190



RICHIE FORCEPS (Str.)  
320-290

ENGLISH MONOPOLAR (MALE 4.8 mm CONNECTOR)			EUROPEAN MONOPOLAR (FEMALE 4.0 mm CONNECTOR)		
Cat #	Description	Size	Cat #	Description	Size
320-200	TUNER-WARWICK SCISSORS (STR.)	7" (17.8 cm)	330-200	TUNER-WARWICK SCISSORS (STR.)	7" (17.8 cm)
320-202	TUNER-WARWICK SCISSORS (CRV.)	7" (17.8 cm)	330-202	TUNER-WARWICK SCISSORS (CRV.)	7" (17.8 cm)
320-210	TUNER-WARWICK SCISSORS (STR.)	9" (23.0 cm)	330-210	TUNER-WARWICK SCISSORS (STR.)	9" (23.0 cm)
320-212	TUNER-WARWICK SCISSORS (CRV.)	9" (23.0 cm)	330-212	TUNER-WARWICK SCISSORS (CRV.)	9" (23.0 cm)
320-220	SURGICAL SCISSORS (STR.)	7" (17.8 cm)	330-220	SURGICAL SCISSORS (STR.)	7" (17.8 cm)
320-222	SURGICAL SCISSORS (CRV.)	7" (17.8 cm)	330-222	SURGICAL SCISSORS (CRV.)	7" (17.8 cm)
320-230	SURGICAL SCISSORS (STR.)	9" (23.0 cm)	330-230	SURGICAL SCISSORS (STR.)	9" (23.0 cm)
320-232	SURGICAL SCISSORS (CRV.)	9" (23.0 cm)	330-232	SURGICAL SCISSORS (CRV.)	9" (23.0 cm)
320-240	WILSON HEY FORCEPS (STR.)	7" (17.8 cm)	330-240	WILSON HEY FORCEPS (STR.)	7" (17.8 cm)
320-242	WILSON HEY FORCEPS (CRV.)	7" (17.8 cm)	330-242	WILSON HEY FORCEPS (CRV.)	7" (17.8 cm)
320-250	WILSON HEY FORCEPS (STR.)	9" (23.0 cm)	330-250	WILSON HEY FORCEPS (STR.)	9" (23.0 cm)
320-252	WILSON HEY FORCEPS (CRV.)	9" (23.0 cm)	330-252	WILSON HEY FORCEPS (CRV.)	9" (23.0 cm)
320-260	ARTERY FORCEPS (STR.)	7" (17.8 cm)	330-260	ARTERY FORCEPS (STR.)	7" (17.8 cm)
320-262	ARTERY FORCEPS (CRV.)	7" (17.8 cm)	330-262	ARTERY FORCEPS (CRV.)	7" (17.8 cm)
320-270	ARTERY FORCEPS (STR.)	9" (23.0 cm)	330-270	ARTERY FORCEPS (STR.)	9" (23.0 cm)
320-272	ARTERY FORCEPS (CRV.)	9" (23.0 cm)	330-272	ARTERY FORCEPS (CRV.)	9" (23.0 cm)
320-290	RICHIE FORCEPS	7" (17.8 cm)	330-290	RICHIE FORCEPS	7" (17.8 cm)
320-292	RICHIE FORCEPS	8" (20.0 cm)	330-292	RICHIE FORCEPS	8" (20.0 cm)
320-296	RICHIE FORCEPS	9" (23.0 cm)	330-296	RICHIE FORCEPS	9" (23.0 cm)

# DIATHERMY INSTRUMENTS



**ADSON**  
320-100



**McINDOE**  
320-110



**GILLIES**  
320-120



**DISSECTING**  
320-130



**GERALD (1x2)**  
320-140



**ADSON BAYONET**  
320-150



**ADSON BAYONET (ANG. UP)**  
320-160



**REMINGTON HOB**  
320-170

## ENGLISH MONOPOLAR (MALE 4.8 mm CONNECTOR)

4.8 mm



Cat #	Description	Tip (mm)	Size
320-100	ADSON	1.0	4 <sup>3</sup> / <sub>4</sub> " (12.0 cm)
320-110	McINDOE	1.0, 2.0	6" (15.0 cm)
320-120	GILLIES (1X2)	—	6" (15.0 cm)
320-122	GILLIES (1X2)	—	7" (17.8 cm)
320-124	GILLIES (1X2)	—	8" (20.0 cm)
320-126	GILLIES (1X2)	—	9" (24.0 cm)
320-130	DISSECTING FORCEPS	1.0, 2.0	6" (15.0 cm)
320-132	DISSECTING FORCEPS	1.0, 2.0	7" (17.8 cm)
320-134	DISSECTING FORCEPS	1.0, 2.0	8 <sup>1</sup> / <sub>4</sub> " (21.0 cm)
320-136	DISSECTING FORCEPS	1.0, 2.0	9 <sup>1</sup> / <sub>2</sub> " (24.1 cm)
320-140	GERALD (1X2)	—	7" (17.8 cm)
320-150	ADSON BAYONET	1.0, 2.0	6 <sup>1</sup> / <sub>4</sub> " (16.0 cm)
320-152	ADSON BAYONET	1.0, 2.0	7 <sup>1</sup> / <sub>2</sub> " (19.1 cm)
320-160	ADSON BAYONET (ANG. UP)	1.0, 2.0	6 <sup>1</sup> / <sub>4</sub> " (16.0 cm)
320-162	ADSON BAYONET (ANG. UP)	1.0, 2.0	7 <sup>1</sup> / <sub>2</sub> " (19.1 cm)
320-164	ADSON BAYONET (ANG. UP)	1.0, 2.0	8 <sup>1</sup> / <sub>4</sub> " (21.0 cm)
320-170	REMINGTON HOB	1.0, 2.0	9 <sup>1</sup> / <sub>2</sub> " (24.1 cm)

## EUROPEAN MONOPOLAR (FEMALE 4.0 mm CONNECTOR)

4.0 mm



Cat #	Description	Tip (mm)	Size
330-100	ADSON	1.0	4 <sup>3</sup> / <sub>4</sub> " (12.0 cm)
330-110	McINDOE	1.0, 2.0	6" (15.0 cm)
330-120	GILLIES (1X2)	—	6" (15.0 cm)
330-122	GILLIES (1X2)	—	7" (17.8 cm)
330-124	GILLIES (1X2)	—	8" (20.0 cm)
330-126	GILLIES (1X2)	—	9" (24.0 cm)
330-130	DISSECTING FORCEPS	1.0, 2.0	6" (15.0 cm)
330-132	DISSECTING FORCEPS	1.0, 2.0	7" (17.8 cm)
330-134	DISSECTING FORCEPS	1.0, 2.0	8 <sup>1</sup> / <sub>4</sub> " (21.0 cm)
330-136	DISSECTING FORCEPS	1.0, 2.0	9 <sup>1</sup> / <sub>2</sub> " (24.1 cm)
330-140	GERALD (1X2)	—	7" (17.8 cm)
330-150	ADSON BAYONET	1.0, 2.0	6 <sup>1</sup> / <sub>4</sub> " (16.0 cm)
330-152	ADSON BAYONET	1.0, 2.0	7 <sup>1</sup> / <sub>2</sub> " (19.1 cm)
330-160	ADSON BAYONET (ANG. UP)	1.0, 2.0	6 <sup>1</sup> / <sub>4</sub> " (16.0 cm)
330-162	ADSON BAYONET (ANG. UP)	1.0, 2.0	7 <sup>1</sup> / <sub>2</sub> " (19.1 cm)
330-164	ADSON BAYONET (ANG. UP)	1.0, 2.0	8 <sup>1</sup> / <sub>4</sub> " (21.0 cm)
330-170	REMINGTON HOB	1.0, 2.0	9 <sup>1</sup> / <sub>2</sub> " (24.1 cm)

## EUROPEAN MONOPOLAR (MALE 4.0 mm CONNECTOR)

4.0 mm



Cat #	Description	Tip (mm)	Size
340-100	ADSON	1.0	4 <sup>3</sup> / <sub>4</sub> " (12.0 cm)
340-110	McINDOE	1.0, 2.0	6" (15.0 cm)
340-120	GILLIES (1X2)	—	6" (15.0 cm)
340-122	GILLIES (1X2)	—	7" (17.8 cm)
340-124	GILLIES (1X2)	—	8" (20.0 cm)
340-126	GILLIES (1X2)	—	9" (24.0 cm)
340-130	DISSECTING FORCEPS	1.0, 2.0	6" (15.0 cm)
340-132	DISSECTING FORCEPS	1.0, 2.0	7" (17.8 cm)
340-134	DISSECTING FORCEPS	1.0, 2.0	8 <sup>1</sup> / <sub>4</sub> " (21.0 cm)
340-136	DISSECTING FORCEPS	1.0, 2.0	9 <sup>1</sup> / <sub>2</sub> " (24.1 cm)
340-140	GERALD (1X2)	—	7" (17.8 cm)
340-150	ADSON BAYONET	1.0, 2.0	6 <sup>1</sup> / <sub>4</sub> " (16.0 cm)
340-152	ADSON BAYONET	1.0, 2.0	7 <sup>1</sup> / <sub>2</sub> " (19.1 cm)
340-160	ADSON BAYONET (ANG. UP)	1.0, 2.0	6 <sup>1</sup> / <sub>4</sub> " (16.0 cm)
340-162	ADSON BAYONET (ANG. UP)	1.0, 2.0	7 <sup>1</sup> / <sub>2</sub> " (19.1 cm)
340-164	ADSON BAYONET (ANG. UP)	1.0, 2.0	8 <sup>1</sup> / <sub>4</sub> " (21.0 cm)
340-170	REMINGTON HOB	1.0, 2.0	9 <sup>1</sup> / <sub>2</sub> " (24.1 cm)

## MONOPOLAR (WITHOUT CONNECTOR)



Cat #	Description	Tip (mm)	Size
350-100	ADSON	1.0	4 <sup>3</sup> / <sub>4</sub> " (12.0 cm)
350-110	McINDOE	1.0, 2.0	6" (15.0 cm)
350-120	GILLIES (1X2)	—	6" (15.0 cm)
350-122	GILLIES (1X2)	—	7" (17.8 cm)
350-124	GILLIES (1X2)	—	8" (20.0 cm)
350-126	GILLIES (1X2)	—	9" (24.0 cm)
350-130	DISSECTING FORCEPS	1.0, 2.0	6" (15.0 cm)
350-132	DISSECTING FORCEPS	1.0, 2.0	7" (17.8 cm)
350-134	DISSECTING FORCEPS	1.0, 2.0	8 <sup>1</sup> / <sub>4</sub> " (21.0 cm)
350-136	DISSECTING FORCEPS	1.0, 2.0	9 <sup>1</sup> / <sub>2</sub> " (24.1 cm)
350-140	GERALD (1X2)	—	7" (17.8 cm)
350-150	ADSON BAYONET	1.0, 2.0	6 <sup>1</sup> / <sub>4</sub> " (16.0 cm)
350-152	ADSON BAYONET	1.0, 2.0	7 <sup>1</sup> / <sub>2</sub> " (19.1 cm)
350-160	ADSON BAYONET (ANG. UP)	1.0, 2.0	6 <sup>1</sup> / <sub>4</sub> " (16.0 cm)
350-162	ADSON BAYONET (ANG. UP)	1.0, 2.0	7 <sup>1</sup> / <sub>2</sub> " (19.1 cm)
350-164	ADSON BAYONET (ANG. UP)	1.0, 2.0	8 <sup>1</sup> / <sub>4</sub> " (21.0 cm)
350-170	REMINGTON HOB	1.0, 2.0	9 <sup>1</sup> / <sub>2</sub> " (24.1 cm)



# BIPOLAR ARTERY SEALER



ARTERY SEALER  
110-750



ARTERY SEALER (NON-STICK)  
110-750 NS



ARTERY SEALER  
110-764



ARTERY SEALER  
110-760



 DETACHABLE CONNECTING  
CABLE 190-180

Cat #	Description	Size
110-750	BIPOLAR ARTERY SEALER	10 <sup>1</sup> / <sub>2</sub> " (26.0 cm)
110-755	BIPOLAR ARTERY SEALER	9 <sup>1</sup> / <sub>2</sub> " (24.0 cm)
110-760	BIPOLAR ARTERY SEALER	6 <sup>1</sup> / <sub>2</sub> " (16.0 cm)
110-762	BIPOLAR ARTERY SEALER	7 <sup>1</sup> / <sub>2</sub> " (19.0 cm)
110-764	BIPOLAR ARTERY SEALER	8 <sup>1</sup> / <sub>2</sub> " (22.0 cm)
110-766	BIPOLAR ARTERY SEALER	9 <sup>1</sup> / <sub>2</sub> " (24.0 cm)
110-768	BIPOLAR ARTERY SEALER	10 <sup>1</sup> / <sub>2</sub> " (26.0 cm)
190-180	SILICONE BIPOLAR ARTERY SEALER CABLES	10' (3.0 m)

\*Add "NS" for Non-Stick Bipolar Artery Sealers





# BIPOLAR SCISSORS



**BIPOLAR SCISSORS (CRV)**  
110-815-18 SIZE 18 CM



**ETHICON BIPOLAR CABLE**  
190-185



# BIPOLAR ELECTRODES

Cat #	Description	Size
310-500	STRAIGHT	18.0 cm
310-510	STRAIGHT	20.0 cm
310-520	STRAIGHT	22.0 cm
310-530	STRAIGHT	27.0 cm
310-540	ANGLED	18.0 cm
310-550	ANGLED	20.0 cm
310-560	ANGLED	22.0 cm
310-570	ANGLED (UPWARD TIP)	16.5 cm
310-580	ANGLED (UPWARD TIP)	20.0 cm
310-590	ANGLED 45°	19.0 cm
310-600	ANGLED 90°	16.0 cm



**STRAIGHT**  
310-500



**ANGLED**  
(Upward Tip)  
310-570



**ANGLED**  
310-540



**ANGLED 45°**  
310-590



**ANGLED 90°**  
310-600



**BI-TURBINATE PROBE** (17.5 cm)  
110-700  
210-700 (DISPOSABLE)

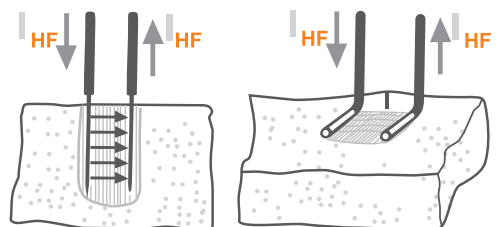



# BIPOLAR ELECTRODES

## SINGLE USE

Cat #	Description	Size
510-500	STRAIGHT	18.0 cm
510-510	STRAIGHT	20.0 cm
510-520	STRAIGHT	22.0 cm
510-530	STRAIGHT	27.0 cm
510-540	ANGLED	18.0 cm
510-550	ANGLED	20.0 cm
510-560	ANGLED	22.0 cm
510-570	ANGLED (UPWARD TIP)	16.5 cm
510-580	ANGLED (UPWARD TIP)	20.0 cm
510-590	ANGLED 45°	19.0 cm
510-600	ANGLED 90°	16.0 cm



**STRAIGHT**  
510-500

**ANGLED**  
(Upward Tip)  
510-570

**ANGLED**  
510-540

**ANGLED 45°**  
510-590

**ANGLED 90°**  
510-600



# BIPOLAR CABLES



## SILICONE BIPOLAR CABLE 10' (3.0 M)

190-100

Instrument Connector: USA 2-Pin Plug  
Generator Connector: 4mm Banana Plug

Compatibility: Valleylab, Conmed, Codman, Olympus  
& Most Bipolar Generator



## SILICONE EUROPEAN BIPOLAR CABLE 10' (3.0 M)

190-110

Instrument Connector: European Flat Plug  
Generator Connector: 4mm Banana Plug

Compatibility: Valleylab, Conmed, Codman, Olympus  
& Most Bipolar Generator



## SILICONE EUROPEAN BIPOLAR CABLE 10' (3.0 M)

190-120

Instrument Connector: European Flat Plug  
Generator Connector: Martin Type

Compatibility: Aesculap, Martin, Berchtold, Wolf



## SILICONE BIPOLAR CABLE 10' (3.0 M)

190-130

Instrument Connector: USA 2-Pin Plug  
Generator Connector: Martin Type

Compatibility: Aesculap, Martin, Berchtold, Wolf

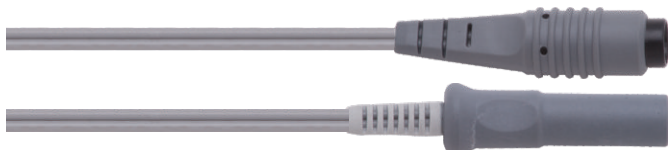

## SILICONE EUROPEAN BIPOLAR CABLE 10' (3.0 M)

190-140

Instrument Connector: European Flat Plug  
Generator Connector: Erbe Type

Compatibility: Erbe, Downs, Siemens



## SILICONE EUROPEAN BIPOLAR CABLE 10' (3.0 M)

190-310

Instrument Connector: Aesculap  
Generator Connector: 4MM Banana Plug

Compatibility: Aesculap, Valleylab, Conmed, Codman,  
& Most Bipolar Generator

HIGH FREQUENCY INNOVATION



# BIPOLAR CABLES



## SILICONE BIPOLAR CABLE 10' (3.0 M)

190-150

Instrument Connector: USA 2-Pin Plug

Generator Connector: Erbe Type

Compatibility: Erbe, Downs, Siemens

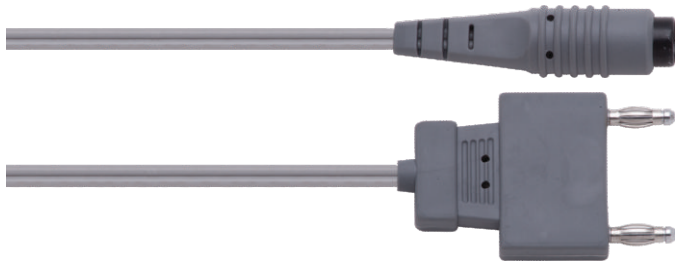

## SILICONE EUROPEAN BIPOLAR CABLE 10' (3.0 M)

190-160

Instrument Connector: European Flat Plug

Generator Connector: Pin Distance 29mm

Compatibility: Valleylab, EMC, Dolley

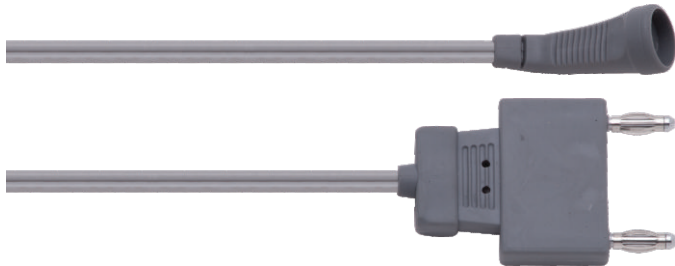

## SILICONE BIPOLAR CABLE 10' (3.0 M)

190-170

Instrument Connector: USA 2-Pin Plug

Generator Connector: Pin Distance 29mm

Compatibility: Valleylab, EMC, Dolley



## SILICONE BIPOLAR CABLE 10' (3.0 M)

190-180

Instrument Connector: Bipolar Artery Sealer

Generator Connector: 4mm Banana Plug

Compatibility: Valleylab, Conmed, Codman, Olympus  
& Most Bipolar Generator



## SILICONE BIPOLAR CABLE 10' (3.0 M)

190-185

Instrument Connector: Ethicon

Generator Connector: 4mm Banana Plug

Compatibility: Valleylab, Conmed, Codman, Olympus  
& Most Bipolar Generator



# MONOPOLAR CABLES



## SILICONE MONOPOLAR CABLE 10' (3.0 M)

190-230

Instrument Connector: Screw Type

Generator Connector: Standard Bovie® 8mm Plug

Compatibility: Valleylab, Conmed, Bovie®

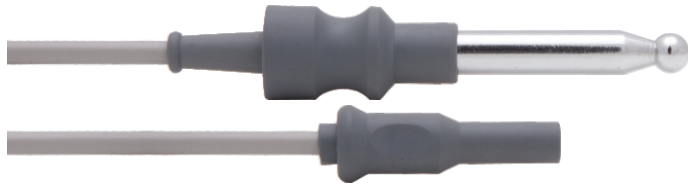

## SILICONE MONOPOLAR ENDOSCOPIC CABLE 10' (3.0 M)

190-240

Instrument Connector: 4mm Female Fitting

Generator Connector: Standard Bovie® 8mm Plug

Compatibility: Valleylab, Conmed, Bovie®

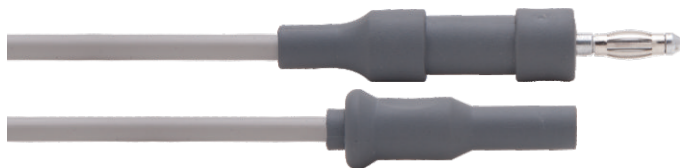

## SILICONE MONOPOLAR ENDOSCOPIC CABLE 10' (3.0 M)

190-250

Instrument Connector: 4mm Female Fitting

Generator Connector: Standard 4mm Banana Plug

Compatibility: Most ES Generators



## SILICONE DIATHERMY CABLE 10' (3.0 M)

190-260

Instrument Connector: 4mm Male Fitting (European Diathermy)

Generator Connector: Standard 4mm Banana Plug

Compatibility: Most ES Generators



## SILICONE DIATHERMY CABLE 10' (3.0 M)

190-280

Instrument Connector:

4.8mm Female Fitting(English Diathermy)

Generator Connector:

Standard 4mm Banana Plug

Compatibility: Most ES Generators



## SILICONE DIATHERMY CABLE 10' (3.0 M)

190-270

Instrument Connector:

4.8mm Female Fitting(English Diathermy)

Generator Connector:

Standard Bovie® 8mm Plug

Compatibility: Valleylab, Conmed, Bovie®



**ROCKER-SWITCH PENCIL**

SINGLE USE

150-104 (3m Cable)



**FOOT CONTROL PENCIL**

SINGLE USE

150-102 (3m Cable)

150-103 (5m Cable)

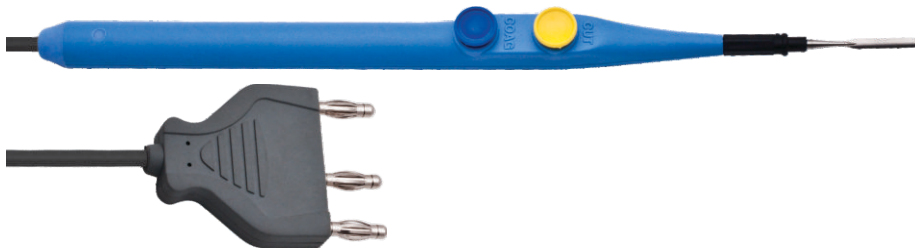

**FINGER-SWITCH PENCIL**

REUSABLE

150-105 (3m Silicon Cable)



**ELECTRODE HANDLE**

REUSABLE

150-107 (3m Silicon Cable)



**FINGER-SWITCH PENCIL**

SINGLE USE

150-100 (3m Cable)

150-101 (5m Cable)



# ELECTRODES (2.4mm)



**BLADE ELECTRODE**

Disposable: 150-110, Reusable: 152-110



**BLADE ELECTRODE (CRV.)**

Disposable: 150-112, Reusable: 152-112



**NEEDLE ELECTRODE**

Disposable: 150-120, Reusable: 152-120



**NEEDLE ELECTRODE (CRV.)**

Disposable: 150-122, Reusable: 152-122



**BALL ELECTRODE (2mm)**

Disposable: 150-130, Reusable: 152-130



**BALL ELECTRODE CRV. (2mm)**

Disposable: 150-132, Reusable: 152-132



**BALL ELECTRODE (3mm)**

Disposable 150-140, Reusable 152-140



**BALL ELECTRODE CRV. (3mm)**

Disposable: 150-142, Reusable: 152-142



**BALL ELECTRODE (4mm)**

Disposable: 150-150, Reusable: 152-150



**BALL ELECTRODE CRV. (4mm)**

Disposable: 150-152, Reusable: 152-152



**BALL ELECTRODE (5mm)**

Disposable: 150-160, Reusable: 152-160



**BALL ELECTRODE CRV. (5mm)**

Disposable: 150-162, Reusable: 152-162



**BLADE ELECTRODE (Shaft 13.0cm)**

Disposable: 150-115, Reusable: 152-115



**NEEDLE ELECTRODE (Shaft 13.0cm)**

Disposable: 150-125, Reusable: 152-125



**BALL ELECTRODE 3mm (Shaft 13.0cm)**

Disposable: 150-145, Reusable: 152-145



**BALL ELECTRODE 5mm (Shaft 13.0cm)**

Disposable: 150-165, Reusable: 152-165



**CIRCLE LOOP ELECTRODE (4.0mm)**

Reusable: 152-510



**CIRCLE LOOP ELECTRODE (6.0mm)**

Reusable: 152-520



**CIRCLE LOOP ELECTRODE (8.0mm)**

Reusable: 152-530



**DIAMOND ELECTRODE**

Reusable: 152-540



**FINE NEEDLE ELECTRODE**

Reusable: 152-550

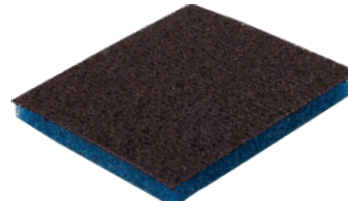

**TIP CLEANER** 150-109



**HOLSTER** 150-108





# ELECTRODES NON-STICK(2.4mm)



**BLADE ELECTRODE Size (6cm)**  
Disposable 150-110-06 NS



**BLADE ELECTRODE Size (6cm)**  
Disposable 151-110-06 NS



**BLADE ELECTRODE Size (7cm)**  
Disposable 150-110-07 NS



**BLADE ELECTRODE Size (7cm)**  
Disposable 151-110-07 NS



**BLADE ELECTRODE Size (10cm)**  
Disposable 150-110-10 NS



**BLADE ELECTRODE Size (10cm)**  
Disposable 151-110-10 NS



**BLADE ELECTRODE Size (16cm)**  
Disposable 150-110-16 NS



**BLADE ELECTRODE Size (16cm)**  
Disposable 151-110-16 NS



**NEEDLE ELECTRODE Size (7cm)**  
Disposable 150-120-07 NS



**NEEDLE ELECTRODE Size (7cm)**  
Disposable 151-120-07 NS



**NEEDLE ELECTRODE Size (10cm)**  
Disposable 150-120-10 NS



**NEEDLE ELECTRODE Size (10cm)**  
Disposable 151-120-10 NS



**NEEDLE ELECTRODE Size (15cm)**  
Disposable 150-120-15 NS



**NEEDLE ELECTRODE Size (15cm)**  
Disposable 151-120-15 NS



**BALL ELECTRODE Size (5cm)**  
Disposable 151-160-05 NS



**BALL ELECTRODE Size (13cm)**  
Disposable 151-160-13 NS



# TUNGSTEN NEEDLE ELECTRODES

(2.4mm)

“**Tungsten needles** are widely used in a variety of surgical procedures like Plastic surgery, ENT surgery, Head & Neck surgery, Oral & Maxillofacial surgery. Tungsten has extremely high melting point (>3400°C) which helps maintain a sharpness compared to stainless steel tips that dull rapidly.”



MICRO NEEDLE ELECTRODE Size (5cm)

(Reusable) 172-120-05



MICRO NEEDLE ELECTRODE ANG. Size (5cm)

(Reusable) 172-122-05



MICRO NEEDLE ELECTRODE Size (6cm)

(Reusable) 172-120-06



MICRO NEEDLE ELECTRODE ANG. Size (6cm)

(Reusable) 172-122-06



MICRO NEEDLE ELECTRODE Size (7cm)

(Reusable) 172-120-07



MICRO NEEDLE ELECTRODE ANG. Size (7cm)

(Reusable) 172-122-07



MICRO NEEDLE ELECTRODE Size (9cm)

(Reusable) 172-120-09



MICRO NEEDLE ELECTRODE ANG. Size (9cm)

(Reusable) 172-122-09



MICRO NEEDLE ELECTRODE Size (12cm)

(Reusable) 172-120-12



MICRO NEEDLE ELECTRODE ANG. Size (12cm)

(Reusable) 172-122-12



MICRO NEEDLE ELECTRODE Size (15cm)

(Reusable) 172-120-15







MICRO NEEDLE ELECTRODE ANG. Size (15cm)

(Reusable) 172-122-15







# LOOP ELECTRODES (2.4mm)









					
Size	1.0X0.4 cm	1.0X0.5 cm	1.0X0.7 cm	1.0X0.8 cm	1.0X1.0 cm
Disposable	150-170-04	150-170-05	150-170-07	150-170-08	150-170-10
Reusable	152-170-04	152-170-05	152-170-07	152-170-08	152-170-10









					
Size	1.0X0.5 cm	1.0X0.7 cm	1.0X0.8 cm	1.0X1.0 cm	1.0X1.5 cm
Disposable	150-175-05	150-175-07	150-175-08	150-175-10	150-175-15
Reusable	152-175-05	152-175-07	152-175-08	152-175-10	152-175-15



						
Size	1.5X0.5 cm	1.5X0.7 cm	1.5X0.8 cm	1.5X1.0 cm	1.5X1.2 cm	1.5X1.5 cm
Disposable	150-180-05	150-180-07	150-180-08	150-180-10	150-180-12	150-180-15
Reusable	152-180-05	152-180-07	152-180-08	152-180-10	152-180-12	152-180-15







						
Size	2.0X0.8 cm	2.0X1.0 cm	2.0X1.2 cm	2.0X1.3 cm	2.0X1.5 cm	2.0X2.0 cm
Disposable	150-190-08	150-190-10	150-190-12	150-190-13	150-190-15	150-190-20
Reusable	152-190-08	152-190-10	152-190-12	152-190-13	152-190-15	152-190-20







# LOOP ELECTRODES (2.4mm)









					
Size	1.0X0.4 cm	1.0X0.5 cm	1.0X0.7 cm	1.0X0.8 cm	1.0X1.0 cm
Disposable	155-170-04	155-170-05	155-170-07	155-170-08	155-170-10
Reusable	157-170-04	157-170-05	157-170-07	157-170-08	157-170-10









				
Size	1.0X0.5 cm	1.0X0.7 cm	1.0X0.8 cm	1.0X1.0 cm
Disposable	155-175-05	155-175-07	155-175-08	155-175-10
Reusable	157-175-05	157-175-07	157-175-08	157-175-10



						
Size	1.5X0.5 cm	1.5X0.7 cm	1.5X0.8 cm	1.5X1.0 cm	1.5X1.2 cm	1.5X1.5 cm
Disposable	155-180-05	155-180-07	155-180-08	155-180-10	155-180-12	155-180-15
Reusable	157-180-05	157-180-07	157-180-08	157-180-10	157-180-12	157-180-15



						
Size	2.0X0.8 cm	2.0X1.0 cm	2.0X1.2 cm	2.0X1.3 cm	2.0X1.5 cm	2.0X2.0 cm
Disposable	155-190-08	155-190-10	155-190-12	155-190-13	155-190-15	155-190-20
Reusable	157-190-08	157-190-10	157-190-12	157-190-13	157-190-15	<del>157-190-20</del>



# CONIZATION ELECTRODES

Cat #	Description	Cone Size
150-195-08	CONIZATION ELECTRODE	( 8x15 mm )
150-195-11	CONIZATION ELECTRODE	( 11x15 mm )
150-195-13	CONIZATION ELECTRODE	( 13x15 mm )
150-198-11	CONIZATION ELECTRODE	( 11x21 mm )
150-198-14	CONIZATION ELECTRODE	( 14x8 mm )



**CONIZATION ELECTRODE**  
(Small) 150-195-08



**CONIZATION ELECTRODE**  
(Medium) 150-195-11



**CONIZATION ELECTRODE**  
(Large) 150-195-13



**CONIZATION ELECTRODE**  
(Medium Extended) 150-198-11



**CONIZATION ELECTRODE**  
(LARGE Shallow) 150-198-14



**ELECTRODE EXTENDER Size (7cm)**  
(Reusable) 152-410-07



**ELECTRODE EXTENDER Size (13cm)**  
(Reusable) 152-410-13



**ELECTRODE EXTENDER Size (18cm)**  
(Reusable) 152-410-18

Cat #	Description	Size
152-410-07	ELECTRODE EXTENDER	7.0cm
152-410-13	ELECTRODE EXTENDER	13.0cm
152-410-15	ELECTRODE EXTENDER	15.0cm
152-410-18	ELECTRODE EXTENDER	18.0cm



# ELECTRODES (4.0mm)



**BLADE ELECTRODE**  
Reusable 162-110



**BLADE ELECTRODE (CRV.)**  
Reusable 162-112



**NEEDLE ELECTRODE**  
Reusable 162-120



**NEEDLE ELECTRODE (CRV.)**  
Reusable 162-122



**BALL ELECTRODE (2mm)**  
Reusable 162-130



**BALL ELECTRODE (CRV.) (2mm)**  
Reusable 162-132



**BALL ELECTRODE (3mm)**  
Reusable 162-140



**BALL ELECTRODE (CRV.) (3mm)**  
Reusable 162-142



**BALL ELECTRODE (4mm)**  
Reusable 162-150



**BALL ELECTRODE (CRV.) (4mm)**  
Reusable 162-152



**BALL ELECTRODE (5mm)**  
Reusable 162-160



**BALL ELECTRODE (CRV.) (5mm)**  
Reusable 162-162



**BLADE ELECTRODE (Shaft 13.0 cm)**  
Reusable 162-115



**NEEDLE ELECTRODE (Shaft 13.0 cm)**  
Reusable 162-125



**BALL ELECTRODE 3mm (Shaft 13.0 cm)**  
Reusable 162-145



**BALL ELECTRODE 4mm (Shaft 13.0 cm)**  
Reusable 162-155



**BALL ELECTRODE 5mm (Shaft 13.0 cm)**  
Reusable 162-165



**ROUND LOOP ELECTRODE (7.0cm) 4.0mm**  
Reusable 162-510-04



**ROUND LOOP ELECTRODE (7.0cm) 6.0mm**  
Reusable 162-510-06



**ROUND LOOP ELECTRODE (7.0cm) 8.0mm**  
Reusable 162-510-08



**ROUND LOOP ELECTRODE (7.0cm) 10.0mm**  
Reusable 162-510-10



**PLATE ELECTRODE SMALL**  
Reusable 162-560







**PLATE ELECTRODE LARGE**  
Reusable 162-370







# LOOP ELECTRODES (4.0mm)









					
Size	1.0X0.4 cm	1.0X0.5 cm	1.0X0.7 cm	1.0X0.8 cm	1.0X1.0 cm
Reusable	162-170-04	162-170-05	162-170-07	162-170-08	162-170-10









					
Size	1.0X0.5 cm	1.0X0.7 cm	1.0X0.8 cm	1.0X1.0 cm	1.0X1.5 cm
Reusable	162-175-05	162-175-07	162-175-08	162-175-10	162-175-15



						
Size	1.5X0.5 cm	1.5X0.7 cm	1.5X0.8 cm	1.5X1.0 cm	1.5X1.2 cm	1.5X1.5 cm
Reusable	162-180-05	162-180-07	162-180-08	162-180-10	162-180-12	162-180-15



						
Size	2.0X0.8 cm	2.0X1.0 cm	2.0X1.2 cm	2.0X1.3 cm	2.0X1.5 cm	2.0X2.0 cm
Reusable	162-190-08	162-190-10	162-190-12	162-190-13	162-190-15	162-190-20



# PATIENT RETURN PLATE



**PATIENT RETURN PLATE REUSABLE**  
150-640 (5m cable)

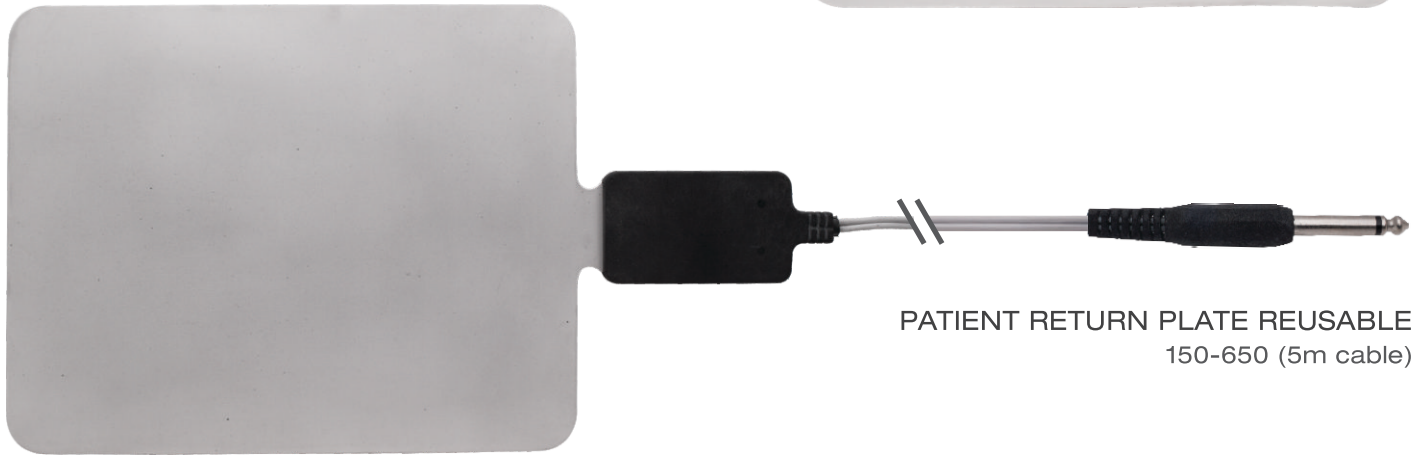

**PATIENT RETURN PLATE REUSABLE**  
150-650 (5m cable)

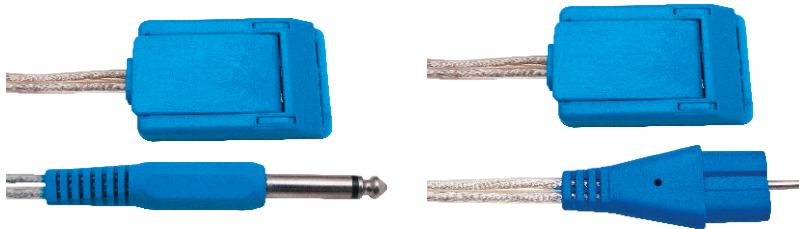

**PATIENT RETURN CABLE**  
150-610 (5m cable)  
150-612 (3m cable)

**PATIENT RETURN CABLE**  
150-600 (5m cable)  
150-602 (3m cable)



**S.S Patient Return Plate (16x12 cm)**  
150-655

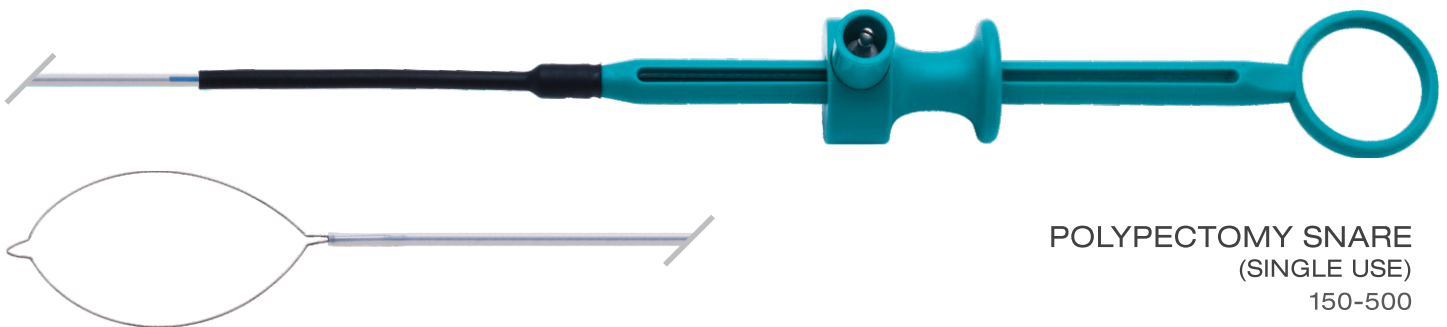

**POLYPECTOMY SNARE**  
(SINGLE USE)  
150-500





# PATIENT RETURN PLATE

## SILICONE



**MONOPOLAR**  
150-660



**BIPOLAR**  
150-670



**ERBE**  
190-315



**VALLEYLAB**  
190-305



**SILICONE RETURN PLATE**  
150-690 (5m cable)



**SILICONE PATIENT RETURN w/c (VALLEYLAB)**  
150-695 (5m cable)



# LAPAROSCOPIC ELECTRODES

## WITHOUT SUCTION

L-HOOK ELECTRODE (36cm)  
150-200



J-HOOK ELECTRODE (36cm)  
150-210



NEEDLE ELECTRODE (36cm)  
150-220



SPATULA ELECTRODE (36cm)  
150-230



BALL ELECTRODE (36cm)  
150-240



## WITH SUCTION

L-HOOK ELECTRODE (36cm)  
150-205



J-HOOK ELECTRODE (36cm)  
150-215



NEEDLE ELECTRODE (36cm)  
150-225



SPATULA ELECTRODE (36cm)  
150-235



BALL ELECTRODE (36cm)  
150-245





# ARTHROSCOPIC ELECTRODES



**DAGGER (12 cm)**  
150-260



**DAGGER (18 cm)**  
150-265



**HOOK (12 cm)**  
150-270



**HOOK (18 cm)**  
150-275



**HOCKEY (12 cm)**  
150-280



**HOCKEY (18 cm)**  
150-285



**NASAL COAGULATION CANNULA**  
150-30-10(10cm) 150-360-26(26cm)



**FRAZIER SUCTION TUBE 11 FRENCH (5<sup>1</sup>/<sub>4</sub>" , 13.5cm)**  
150-300



**FRAZIER SUCTION TUBE 11 FRENCH (8" , 20.5cm)**  
150-310



**FRAZIER SUCTION TUBE 11 FRENCH (16" , 40.6cm)**  
150-320



**SUCTION COAGULATOR**  
150-350 (3m Cable)



**GRAVES VAGINAL SPECULUM  
WITH SMOKE EVACUATION TUBE**

**LARGE**   **MEDIUM**   **SMALL**  
130-100   130-102   130-103



**DISPOSABLE TUBE**  
**LARGE**   130-100-DT  
**MEDIUM**   130-102-DT  
**SMALL**   130-103-DT



**DISPOSABLE TUBE**  
**LARGE**   130-117-DT  
**MEDIUM**   130-118-DT



**VU-MORE (GRAVES) SPECULUM  
WITH SMOKE EVACUATION TUBE**

**LARGE**   **MEDIUM**  
130-117   130-118



**VU-MAX SPECULUM  
WITH SMOKE EVACUATION TUBE**

**GRAVES (MEDIUM)**   **PEDERSON (MEDIUM)**  
130-105   130-115



**DISPOSABLE TUBE**  
**GRAVES (MEDIUM)**  
130-105-DT  
**PEDERSON (MEDIUM)**  
130-115-DT



**DISPOSABLE TUBE**  
**LARGE**   130-200-DT  
**MEDIUM**   130-202-DT  
**SMALL**   130-203-DT



**PEDERSON VAGINAL SPECULUM  
WITH SMOKE EVACUATION TUBE**

**LARGE**   **MEDIUM**   **SMALL**  
130-200   130-202   130-203



**SPECULUM  
(Chinese Pattern)**

**MEDIUM**   130-255  
**SMALL**   130-257

**HIGH FREQUENCY INNOVATION**



# ELECTROSURGICAL INSTRUMENTS FOR GYNECOLOGY



**COLLIN SPECULUM**  
WITH SMOKE EVACUATION TUBE

**LARGE**   **MEDIUM**   **SMALL**  
130-111   130-112   130-113



**CUSCO SPECULUM**  
WITH SMOKE EVACUATION TUBE

**LARGE**   **MEDIUM**   **SMALL**  
130-108   130-109   130-110

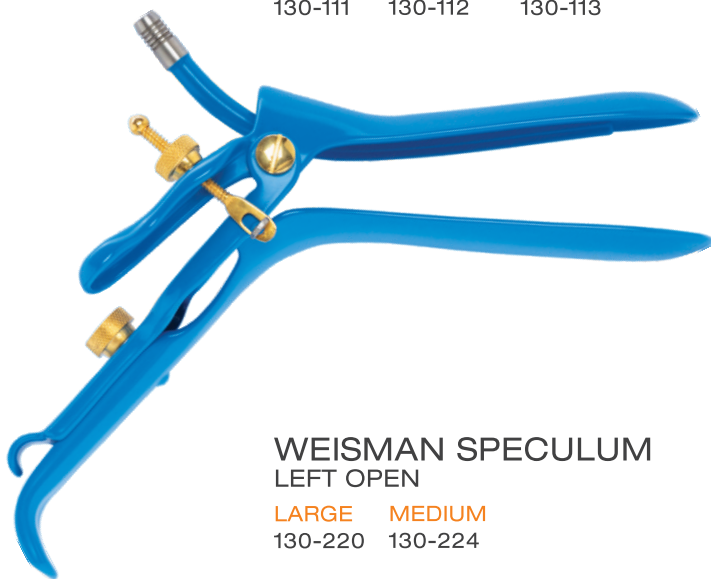

**WEISMAN SPECULUM**  
LEFT OPEN

**LARGE**   **MEDIUM**  
130-220   130-224

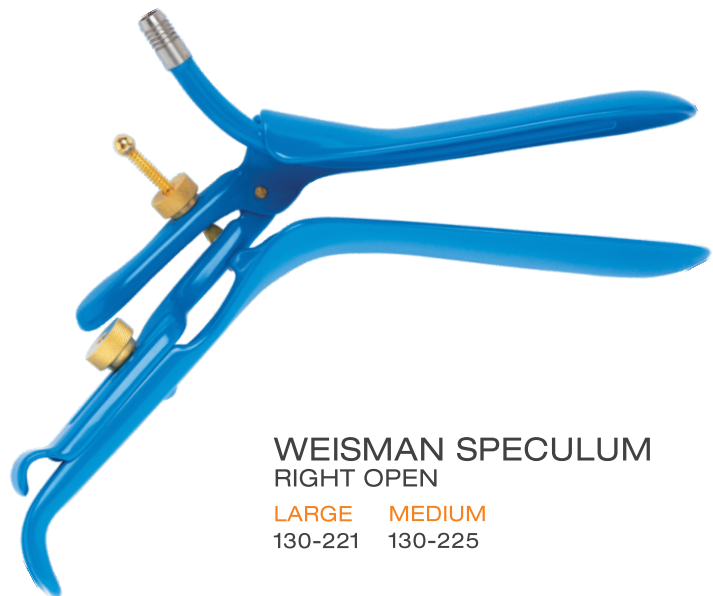

**WEISMAN SPECULUM**  
RIGHT OPEN

**LARGE**   **MEDIUM**  
130-221   130-225

**DRESSING FORCEPS**

130-180 (21 cm)  
130-181 (25 cm)



**TISSUE FORCEPS**

130-185 (21 cm)  
130-186 (25 cm)



**IRIS HOOK (25 cm)**

130-175



**EMMET HOOK (25 cm)**

130-170



**STRAIGHT HOOK (25 cm)**

130-176



**TWO-PRONG HOOK(25 cm)**

130-178



**THREE-PRONG HOOK(25 cm)**

130-179





# ELECTROSURGICAL INSTRUMENTS FOR GYNECOLOGY



LATERAL VAGINAL  
RETRACTOR 130-120



KOGAN ENDOCERVICAL  
SPECULUM

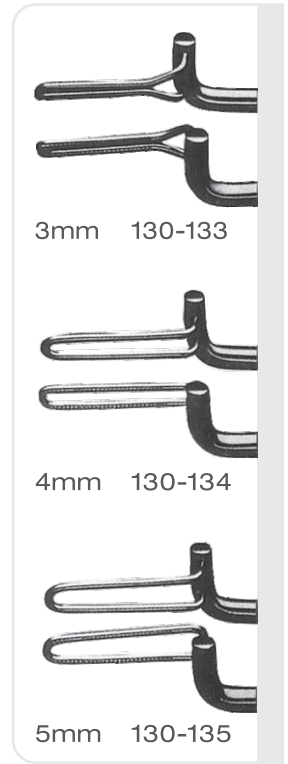

LATERAL RETRACTOR  
(WIDE OPEN) 130-122



RIGBY RETRACTOR  
130-150 45



GELPI RETRACTOR  
130-140



# ELECTROSURGICAL INSTRUMENTS FOR GYNECOLOGY

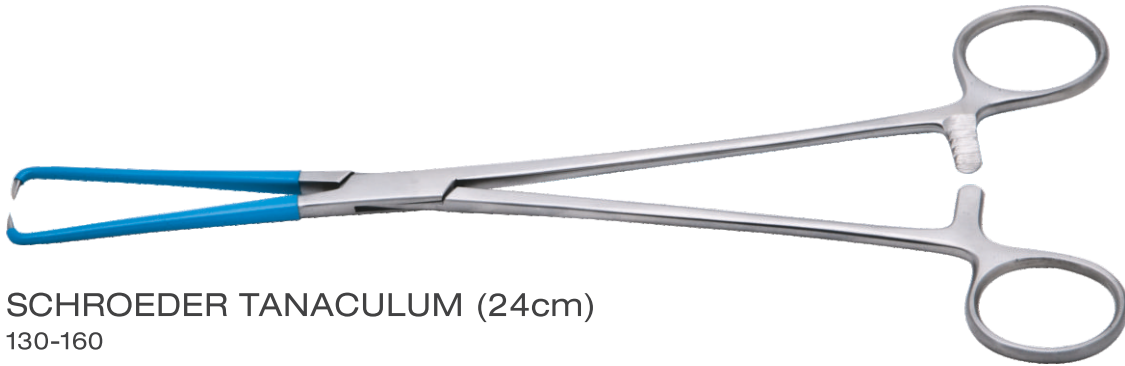

SCHROEDER TANACULUM (24cm)  
130-160



SCHROEDER TANACULUM (24cm)  
130-161

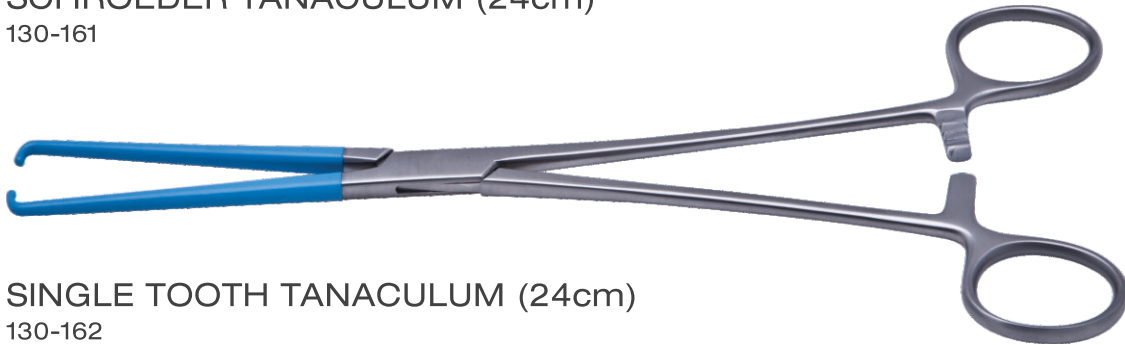

SINGLE TOOTH TANACULUM (24cm)  
130-162



CAMPION FORCEPS (22cm)  
130-168

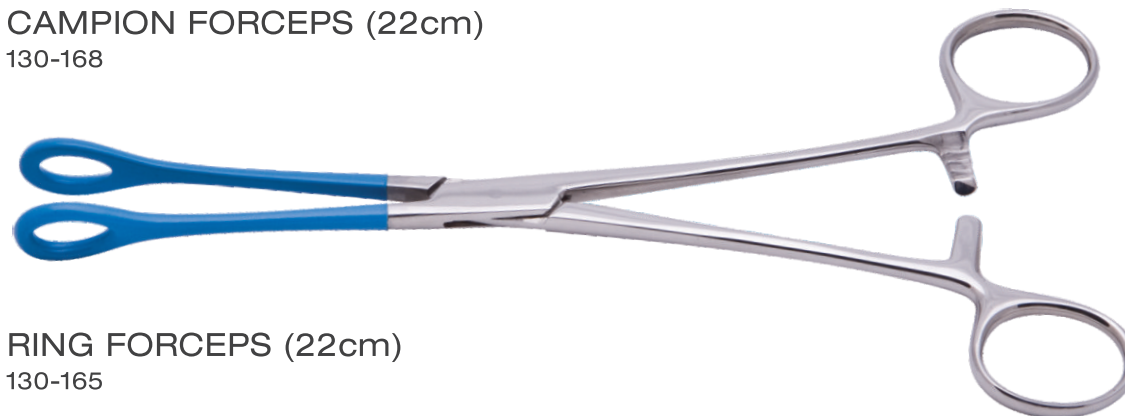

RING FORCEPS (22cm)  
130-165



# LASER SURGERY INSTRUMENTS FOR GYNECOLOGY



## GRAVES VAGINAL SPECULUM

WITH SMOKE EVACUATION TUBE

- LARGE** 140-100
- MEDIUM** 140-102
- SMALL** 140-103



## PEDERSON VAGINAL SPECULUM

WITH SMOKE EVACUATION TUBE

- LARGE** 140-200
- MEDIUM** 140-202
- SMALL** 140-203



## COLLIN SPECULUM

WITH SMOKE EVACUATION TUBE

- LARGE** 140-111
- MEDIUM** 140-112
- SMALL** 140-113



## LATERAL VAGINAL RETRACTOR

140-120



## KOGAN ENDOCERVICAL SPECULUM

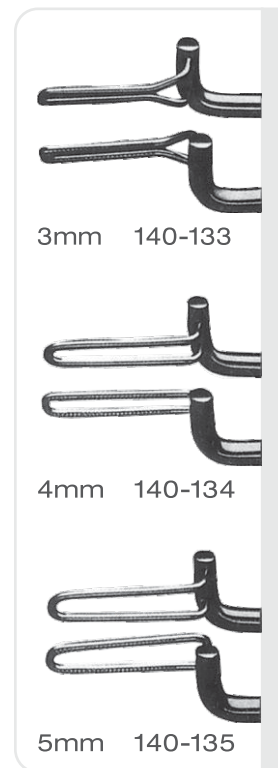





# LASER SURGERY INSTRUMENTS FOR GYNECOLOGY



GELPI RETRACTOR  
140-140



RIGBY RETRACTOR  
140-150



SCHROEDER TENACULUM  
140-160



IRIS HOOK  
140-175



EMMETT HOOK  
140-170



STRAIGHT HOOK  
140-176



TWO-PRONG HOOK  
140-178



THREE-PRONG HOOK  
140-179